



# Pisanka prvih riječi

prema Montessori pedagogiji



auto auto auto

\_\_\_\_\_

\_\_\_\_\_

\_\_\_\_\_

\_\_\_\_\_

\_\_\_\_\_



Nijedan dio ovih materijala ne smije se reproducirati, pohraniti ni prenositi u bilo kojem obliku bez dopuštenja autora. Neovlaštena uporaba ili umnožavanje zabranjeni su.

## Upute

- Koristite ovaj materijal zajedno s Montessori mobilnim alfabetom.
- Kartice ispišite onoliko puta koliko je potrebno.
- Nije potrebno slijediti abecedni red. U Montessori okruženju slova se najčešće uvode prema skupinama glasova, primjerice: a, m, t, s. Više o skupinama slova i načinu njihova uvođenja možete pronaći u lekciji „Prve aktivnosti sa brusnim slovima“.
- Igrajte se materijalom. Promatrajte dijete, predložite aktivnosti i prilagodavajte ih njegovu interesu.

## Dodatne aktivnosti za djecu

- Složi riječ mobilnim alfabetom prije pisanja.
- Prepiši riječ, a zatim je pokušaj napisati samostalno.
- Pronadi predmet u kući koji počinje istim glasom.
- Pronadi druge riječi koje počinju istim glasom ili slovom.
- Na praznim predlošcima na zadnjoj stranici zapiši vlastite riječi i dopunjavaj ih svojim crtežima.
- Pripremi više kartica sa istim početnim slovom.
- Igraj igru: „Čujem glas...“, zatim potraži odgovarajuću karticu.

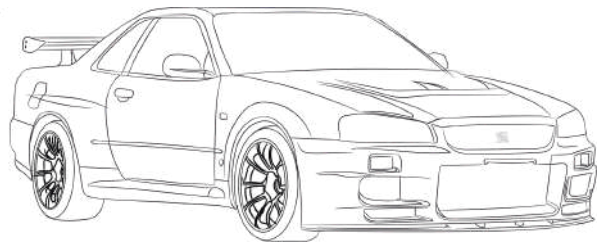

auto

auto

auto



bob

bob

bob



čme

čme

čme



čaj

čaj

čaj

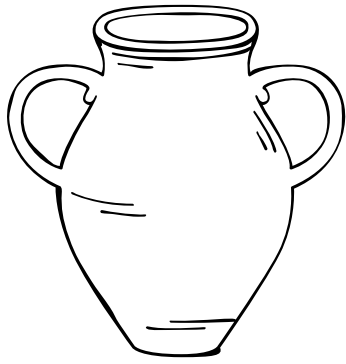

cup

cup

cup



dam

dam

dam



čak

čak

čak

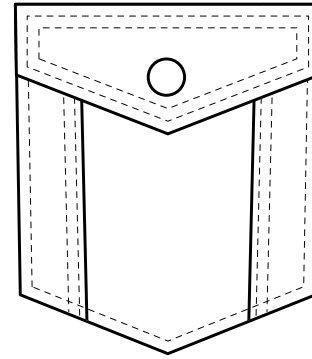

džep

džep

džep

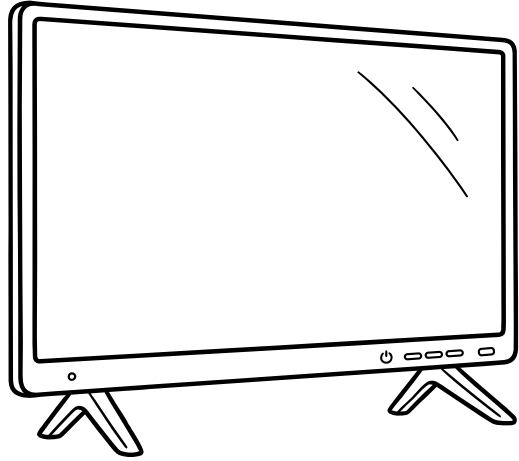

ekran

ekran

ekran

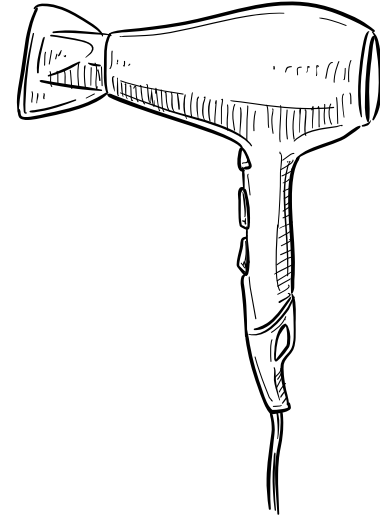

fen

fen

fen



grad

grad

grad



hrast

hrast

hrast

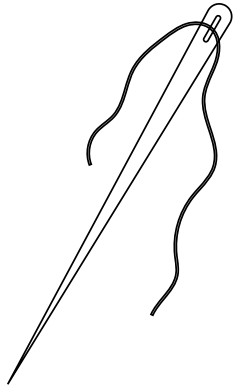

igla

igla

igla



jeř

jeř

jeř

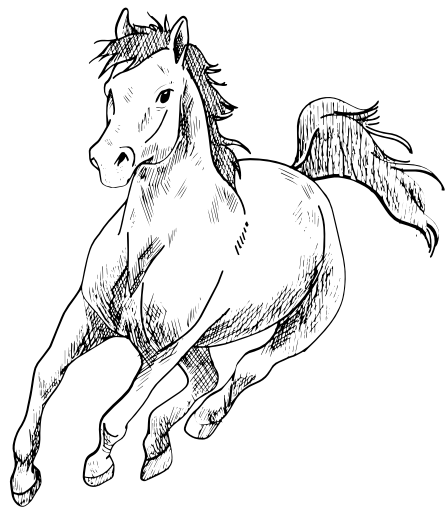

kanj

kanj

kanj



list

list

list

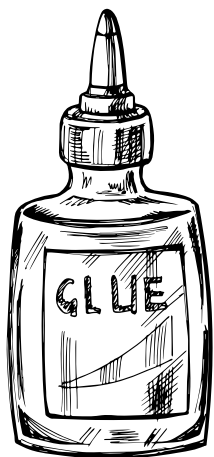

ljepila

ljepila

ljepila



miš

miš

miš



nos

nos

nos

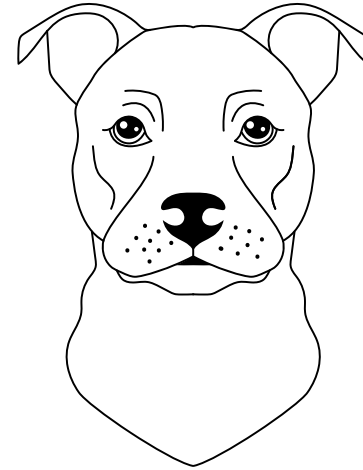

njuška

njuška

njuška

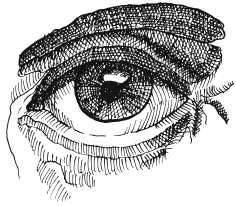

oko

oko

oko



pas

pas

pas

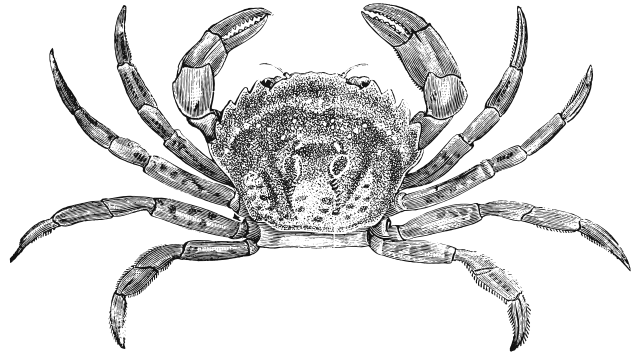

crab

crab

crab

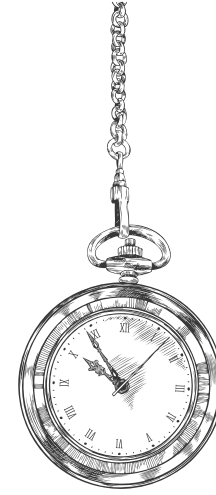

watch

watch

watch



šal

šal

šal



torba

torba

torba



who

who

who



wuk

wuk

wuk

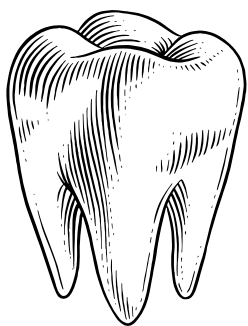

zub

zub

zub

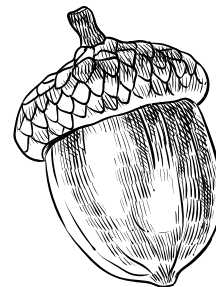

žir

žir

žir

